

How To Make Protective Face Masks

WASHABLE COTTON VERSION (NON POCKET)



WATCH THE FULL VIDEO TUTORIAL AT:
www.youtube.com/nicoleherrick

SUPPLIES NEEDED

- For outer layer - Tightly woven fabric eg cotton
- For inner layer - 100% cotton or bamboo fabric
- For optional internal filter layer - Thick interfacing (non adhesive)
(The filter layer is not recommended for children's masks)
- Thin elastic Eg: 3mm (1/4in) wide.
Length: Child Small 65cm 25.6in, Child Large 70cm 27.5in,
Adult Small 75cm 29.5in, Adult Medium 80cm 31.5in, Adult Large 85cm 33.5in
- Thin ribbon Eg 10mm (3/8in) wide, approx 8cm 3in long
- Wire twist ties eg plant ties, trash bag ties approx 7cm (2.5in)
- Scissors
- Needle and thread or sewing machine

STEP 1

Fold the fabric over, right sides facing each other, to be able to cut 2 of the pattern piece in each fabric. Align the straight arrow on the pattern with the straight edge of your fabric. Place a pin, clip or chalk mark so you know where the nose is.

STEP 2

Join the two halves of each layer by sewing along the curved edge.

STEP 3

Flatten out the inner layer with the wrong side facing towards you. Cut a piece of ribbon 1cm (1/2in) longer than your twist tie. Twist ties can vary in size and can be folded if needed. Aim for approx 7cm (2.5in). Fold the ribbon in half to find the mid point. Place the mid point on the centre seam, 1cm (1/2in) from the top nose point. Make sure the mask seam is pressed to the right hand side before pinning your ribbon in place. Sew the top, right and bottom edge of the ribbon to create a channel, leaving the left hand side open to slide in the nose wire. Once the nose wire has been placed inside the ribbon, sew up the final side to enclose.

STEP 4

Place the interfacing layer opened out flat, seam up, then on top place the outer layer, seam facing down, then on top place the inner layer, seam facing up. Sew along the top edge, right side edge, then the bottom edge (leave the left side open). Turn the mask right side out. Fold in the remaining side on itself, pin and sew shut.

STEP 5

Cut your elastic to the right length for you pattern. Tie the elastic in a loop. Place the loop on top of the inner side of the mask with one side of the loop on each side of the mask. Fold the edges of the mask inwards over the elastic, pin and sew the edges, making sure your elastic still moves freely. You can adjust the knot to fit each person.

STEP 6

Top stitch all the way around the mask being carefully not to stitch through the elastic. Top stitch along the centre seam.

WASHING INSTRUCTIONS: Cold hand wash only. Do not iron or place in dryer. Masks are to be changed as soon as they become damp. Wash each mask before wearing again.

SIZING

Adult: Small Medium & Large
Child: Small & Large

Please note:

All masks are to be made and worn at your own risk. Fabrics vary. Please check the breath-ability of fabrics, especially for children. Monitor children to check if they are able to breathe safely. These masks are effective at slowing droplet spread however they are not a guaranteed defence against viruses.

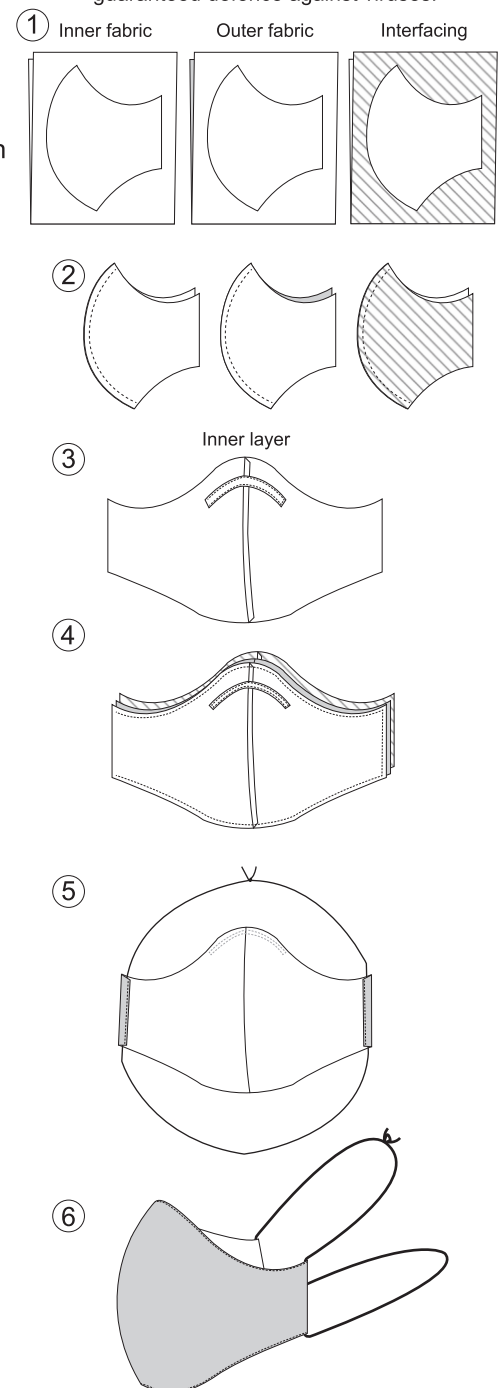

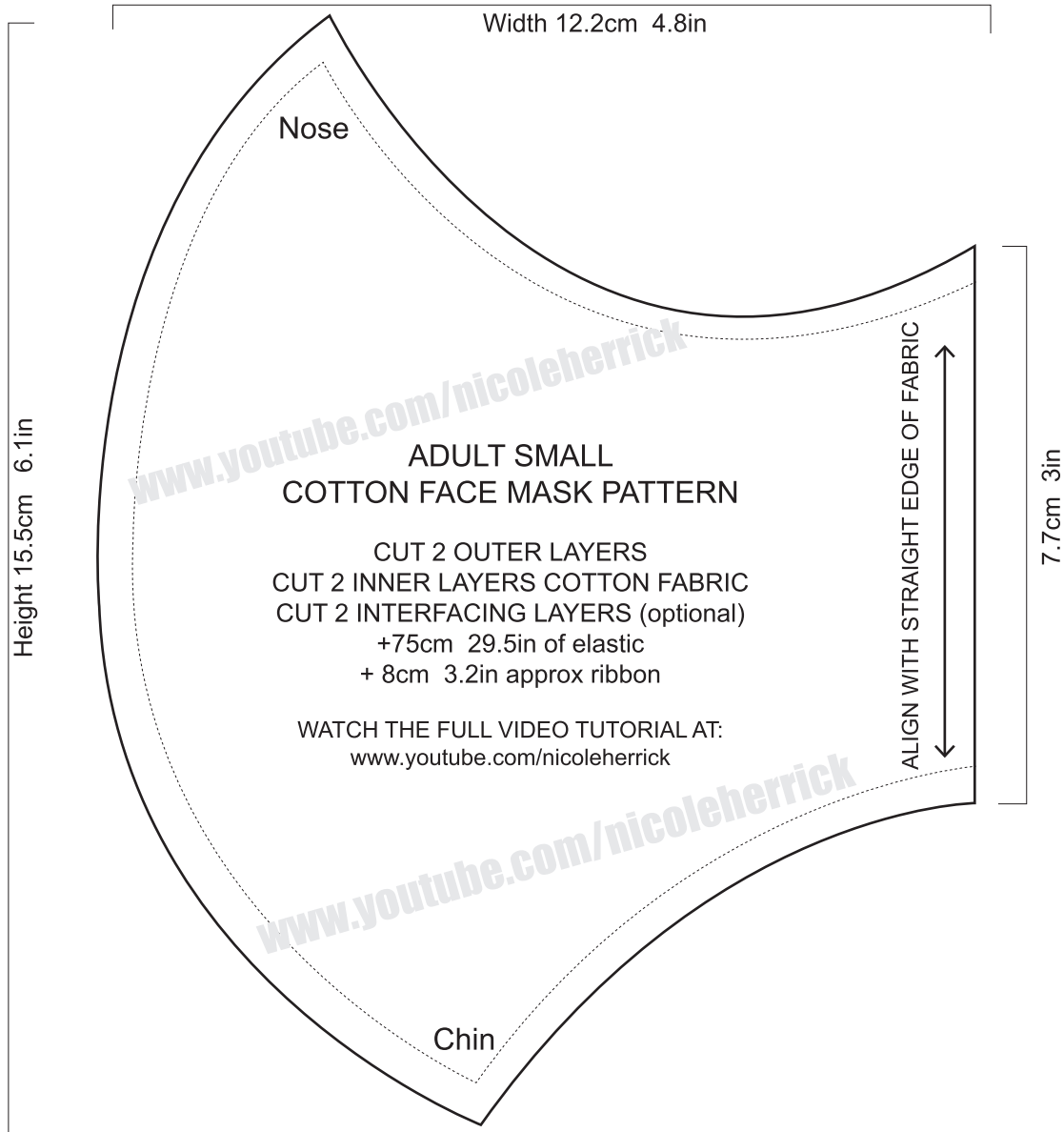

CUT LINE —————
SEW LINE
(5mm 1/4in seam allowance)

SCALE 5cm

SCALE 2in

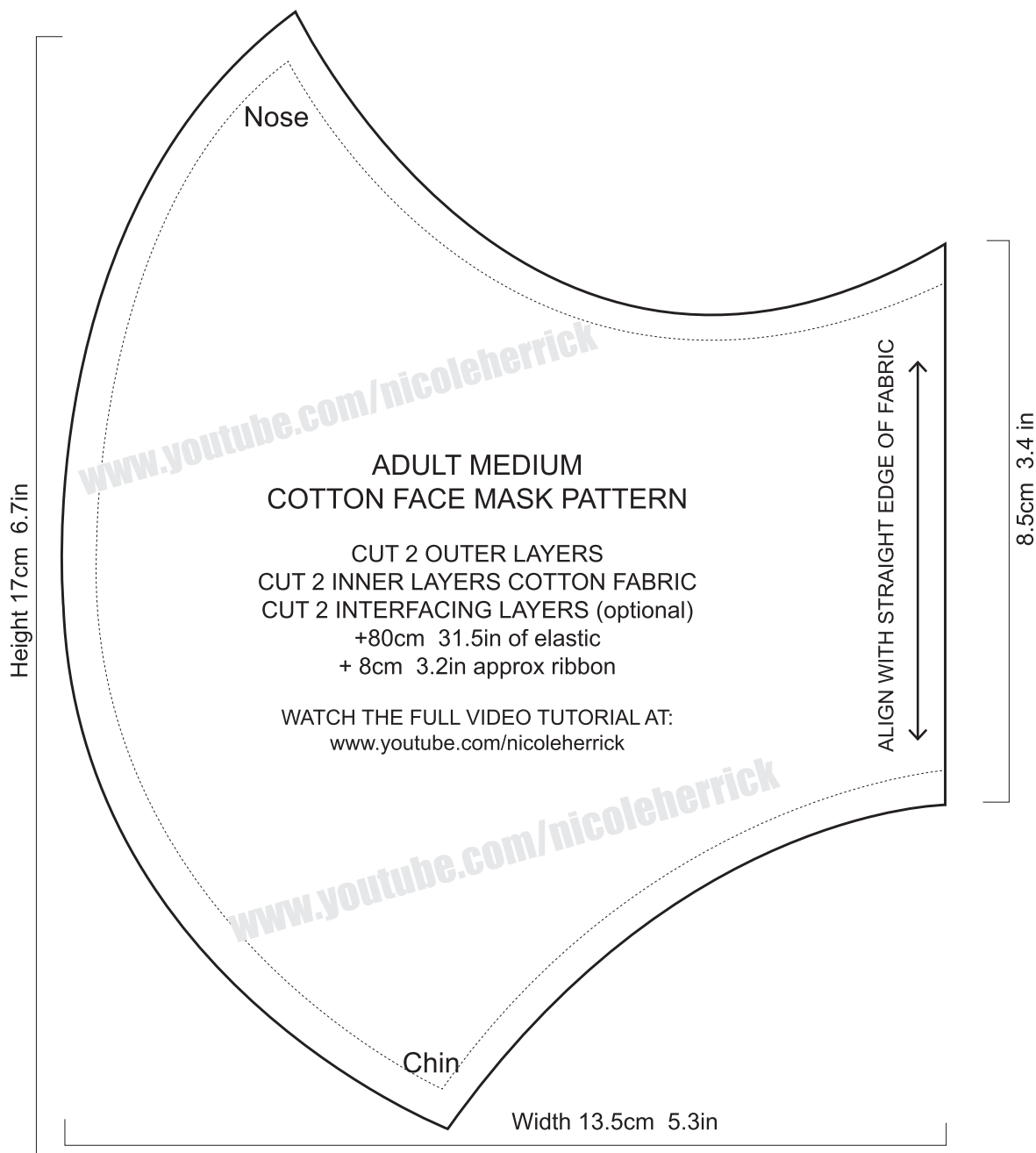

CUT LINE —————
SEW LINE
(5mm 14/in seam allowance)

SCALE 5cm

SCALE 2in

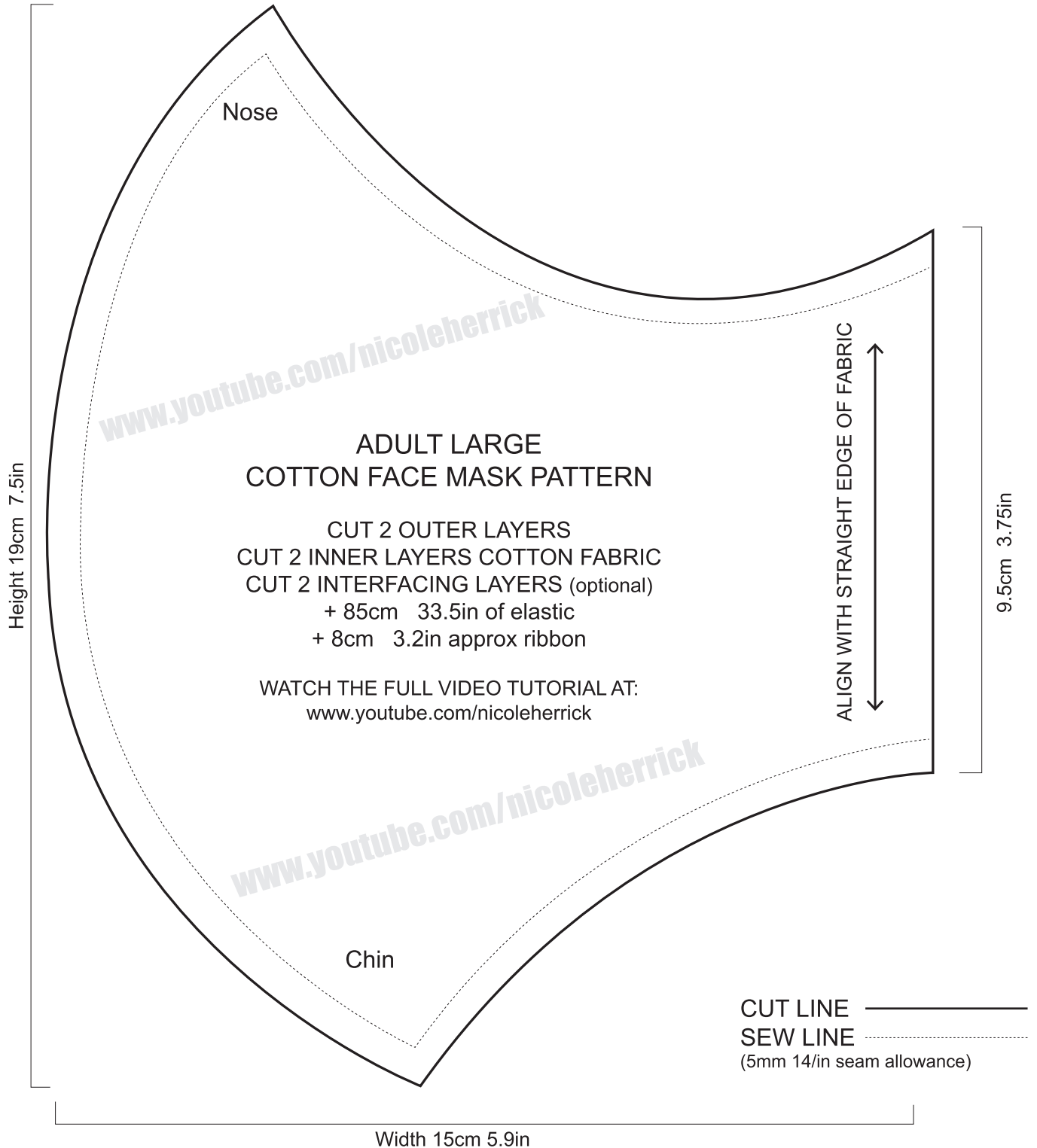

SCALE 5cm



SCALE 2in

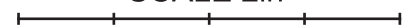

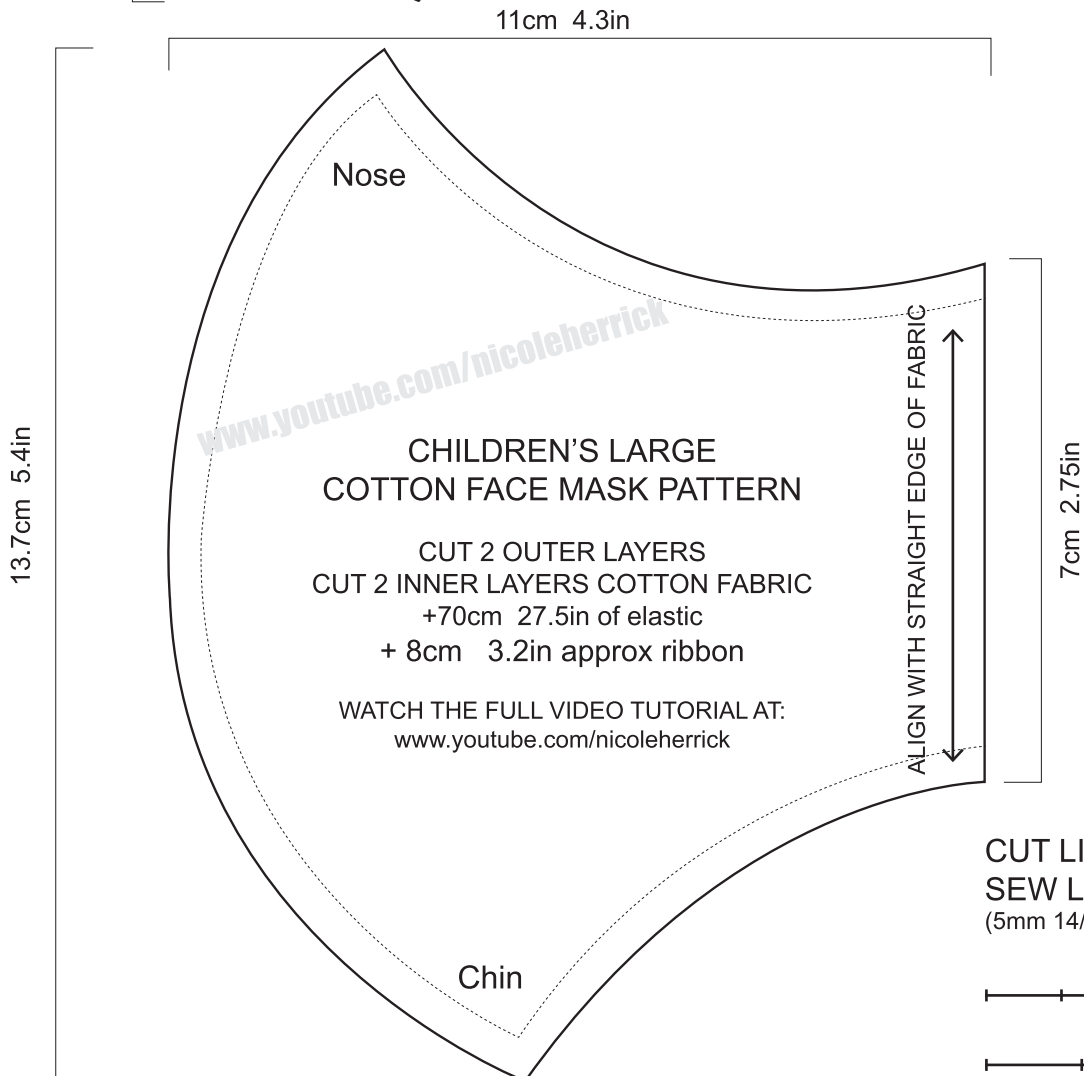
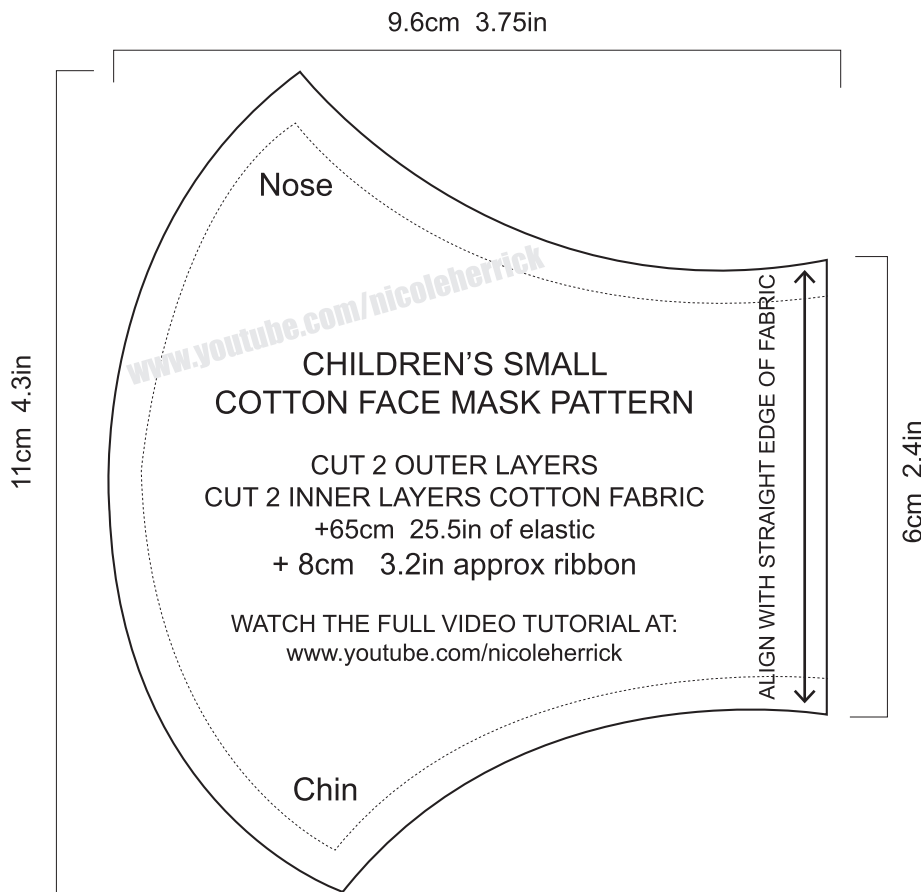

CUT LINE _____
SEW LINE
(5mm 1/4in seam allowance)

SCALE 5cm



SCALE 2in

